

ProFlex® G5

SERVICE MANUAL

Your System Configuration

Temperature Controls

Microprocessor - 4th Gen

2 Hoses / 2 Guns

Single Motor / Pump

Voltage Requirements

220 VAC, Single Phase, 40 A

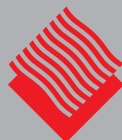

**Hot Melt
Technologies, Inc.**

No One Puts It Together Like HMT[®]

1723 W. Hamlin Rd | Rochester Hills, MI 48309

248.853.2011 | www.hotmelt-tech.com



Intended Use

Benchmark® and ProFlex® adhesive melters and components are designed to melt and pump thermoplastic hot melt adhesives and sealants. Any other use is considered to be unintended. Hot Melt Technologies (HMT®) will not be liable for personal injury or property damage resulting from unintended use. Intended use includes the observance of HMT safety instructions. HMT recommends obtaining detailed information on the hot melt materials being used.

- ▶ The product is only intended for use in industrial applications and may only be used to melt and pump thermoplastic hot melt adhesives (e.g. EVA, PSA, APO, Polyamid).
- ▶ The product may only be installed, assembled, commissioned, operated, maintained, repaired, de-commissioned and disposed of by trained personnel.
- ▶ The product may only be operated with compatible original components and original accessories from Hot Melt Technologies Inc.
- ▶ The product is to be used exclusively for the purpose described herein and within the limits defined in this document. The product must not be modified with respect to its structure or its safety features without the written consent of Hot Melt Technologies. No changes to the software or hardware of HMT products are permitted. Only use original spare parts, original accessories or standard parts that have been approved by HMT.

The instructions are part of this product. No applications other than those described in the instructions are permitted.

Improper Use

Examples of misuse of the product include:

- ▶ Melting and pumping of unsuitable adhesives (e.g. PUR-Polyurethane hot melt adhesives)
- ▶ In defective condition
- ▶ With electrical cabinet open
- ▶ With the tank lid open
- ▶ Melting and pumping materials which, when under vacuum or pressure, can pose a health hazard or endanger safety in the workplace (e.g. solvents, explosive or highly flammable materials)
- ▶ Cleaning the product with highly flammable materials (e.g. solvents)
- ▶ Use in environments that require cleaning of the product with jets or sprays of water
- ▶ Processing of food

Residual Risks

In the design of the Benchmark and ProFlex systems, every measure was taken to protect personnel from potential danger. However, some residual risks can not be avoided:

- ▶ Risk of burns from hot material
- ▶ Risk of burns when filling the tank, from the tank lid, and from the hose and gun exposed metal surfaces.
- ▶ Risk of burns when conducting maintenance and repair work for which the melter or components must be heated up.
- ▶ Material fumes may be hazardous. Always avoid direct inhalation.



Table of Contents 3

Safety & Set Up..... 4-5

Operating Instructions..... 6-8

 Front Panel Controls..... 6

 Temperature and System Controls..... 7

 Front Panel 8

Electrical 9-11

 Fuse & Relay Chart..... 9

 Schematic..... 10

 Ground Fault Equipment Protection (GFEP)..... 11

Warranty Information 12





STOP



If incorrectly used, this machine can cause severe injury. Those who use and maintain the machine should be trained in its proper use, warned of its dangers, and should read the entire manual before attempting to set up, operate, adjust or service the machine.

WARNING

- ▶ Do not allow the pump motor to stall. A prolonged stall may damage the motor and other components.
- ▶ Do not connect or disconnect electrical connectors, or remove components, with the power on. This will prevent arcing of electrical contacts and possible failure of components.
- ▶ Always close and secure the control panel access cover to protect internal electrical components.
- ▶ Always operate the system with the tank full and lid on.
- ▶ Prior to dismantling, assembly, or adjustment of certain service parts (hose/gun fittings, pump assemblies, etc.), the part(s) being serviced should be preheated to reduce the chance of stripping threads or ruining components.
- ▶ Working on or around hot melt adhesives and equipment can cause severe burns.
- ▶ Use eye protection, gloves and protective clothing while operating and/or servicing hot melt equipment.
- ▶ Before installing any hot melt equipment, determine proper electrical requirements per all applicable codes.

At Hot Melt Technologies, we pay special attention to the needs of operators and service personnel when designing equipment, but molten hot melt adhesives are dangerous and can cause severe burns. Extreme care must be exercised to insure personnel safety.

Fire, explosion, personal injury, property, and/or equipment damage can result if the material(s) used in or around any hot melt adhesive supply unit are toxic, heat, or fire sensitive. Always read the manufacturer's recommended use guidelines.

All HMT units are equipped with over temperature protection as a necessary safety device. Run-away heating can cause hot melt materials to exceed their flashpoint.



Prevent Serious Equipment Damage

Protect your hot melt equipment by installing a GFEP (Ground Fault Equipment Protector) device in your distribution panel.

HMT® recommends that hot melt systems be protected from unintended line-to-ground currents by installing an appropriate ground fault equipment protection (GFEP) device. Contact HMT Technical Service & Support or a qualified electrical contractor for more information. When installing a GFEP device always comply with local electrical codes.

LEGEND: SAFETY SYMBOLS

	Electric Shock Hazard: Line Voltage Present with Machine Power Off. Risk of electrical Shock or Burn
	Disconnect Power Before Servicing
	Consult Service Manual
	Warning/ Caution: Used to draw attention to Hot Surface Warnings, Over Temp Alarms, Hose Routing Practices, and other safety notifications.
	Hot Surface: Surface and surrounding area may be hot. Exercise extreme caution and utilize proper Personal Protective Equipment (PPE).

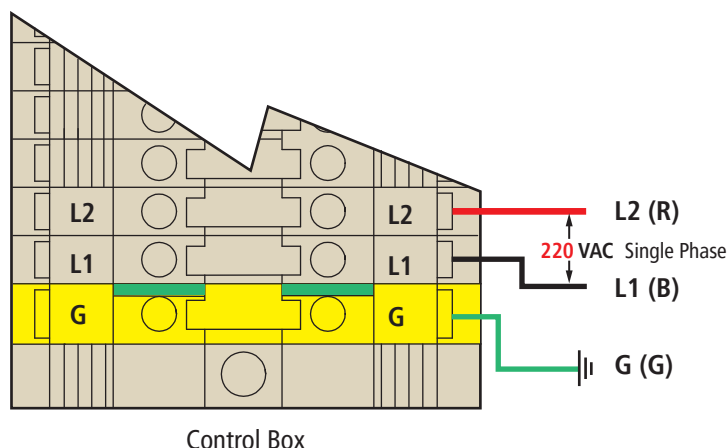

Before Using Your Hot Melt System

It is your responsibility and obligation to make sure your system:

- ▶ Has been properly installed off the floor and on a steady, level work surface away from combustible materials.
- ▶ Has been located in such a way that the controls are away from the operator and that the control panel is securely closed at all times.
- ▶ Is the right capacity system for the intended use.
- ▶ Is connected to the proper power supply. (See Below).
- ▶ Is only used to do what a hot melt system is designed to do.
- ▶ Is not used by anyone unable to operate it properly.
- ▶ Is used in an area where the room temperature does not fall below 65 °F.
- ▶ Is used in an area which is free from blowing air caused by cooling fans, open doors or windows.

Basic Electrical Power Connections

For 220 VAC Operation

- ▶ A fused 40 A 220 VAC electrical supply is required. Performance problems will occur with voltages less than 208 VAC or greater than 240 VAC.
- ▶ Total amperage draw will depend on the final system configuration; number of hoses & length, guns, accessories, etc.
- ▶ Do not allow the system to share the same circuit with other electrical items. A dedicated supply is recommended.
- ▶ Do not use an extension cord.
- ▶ If you change the configuration of your system in any way that may affect the electrical requirements (ex. add a gun, longer hose, automate, etc.) call HMT Technical Service & Support at 248-853-2011 for assistance.



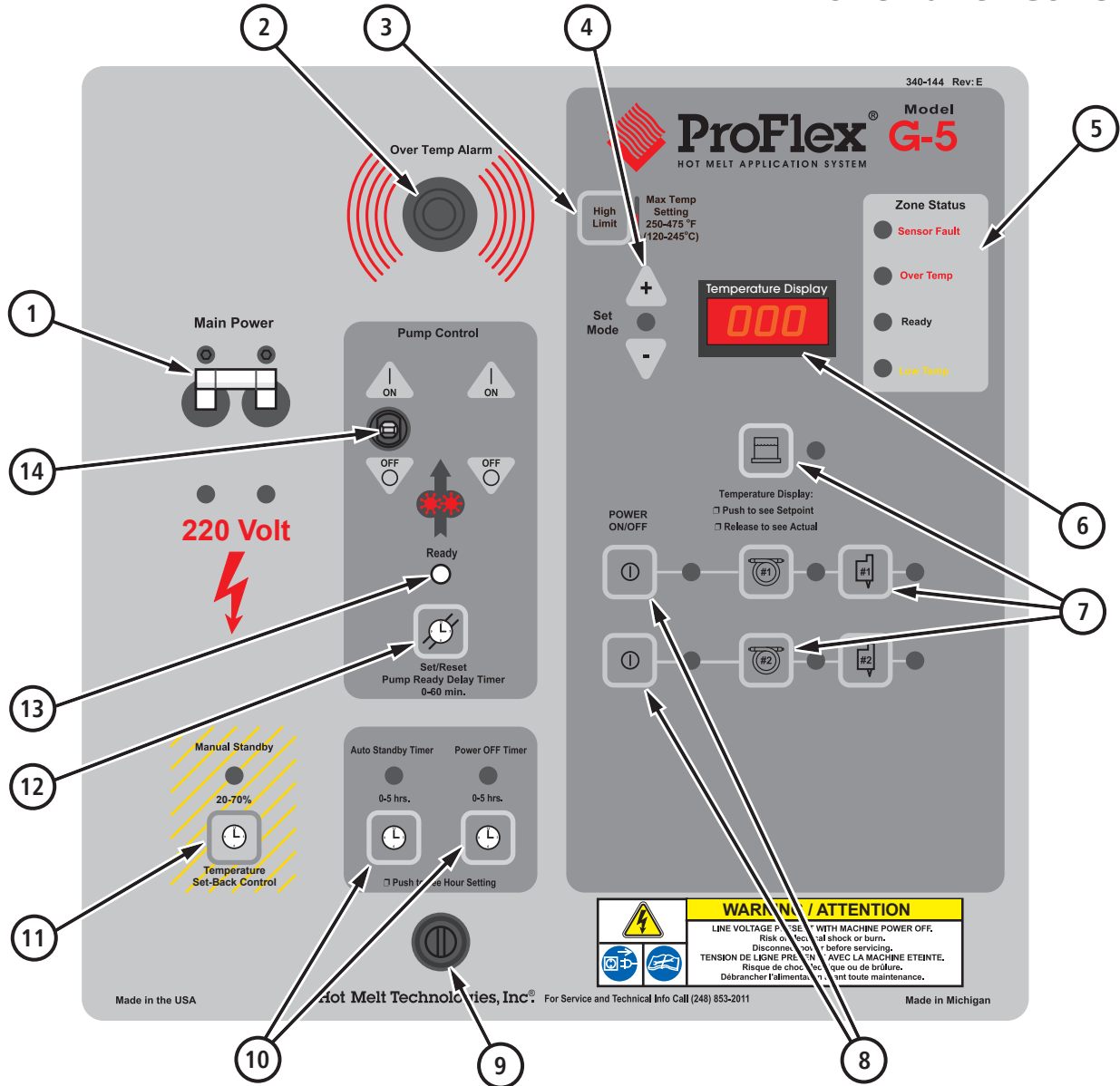

- ① **Main Power Switch:** Turns the system "ON" or "OFF."
- ② **Audible Over Temp Alarm:** Sounds when a zone is in Over Temp. (See #6).
- ③ **High Limit:** Limits the Set Point for any zone; adjustable between 250°F and 475°F.
 - ▶ To Adjust the High Limit: Turn the system off. Press and hold down the High Limit button and turn the Power Switch ON. The display will show the current High Limit. Release the High Limit button and use the Arrow Keys to adjust High Limit Up or Down. Turn the Main Power Switch OFF then ON again. All zones will default to the new High Limit and must be reset.
- ④ **Arrow keys and Set Mode LED:** See # 3, 10, 11, and 15 for usage.

- ⑤ **Zone Status:**
 - Sensor Fault:** The LED will light and indicate that no RTD sensor input is present in the selected zone. See page 7 for Tank Zone fault.
 - Over Temp:** The LED will light and affected zone LED will blink if temperature exceeds High Limit by 25°F (14°C). The audible Over Temp Alarm will also sound.
 - Ready:** The LED will light when the zone temperature rises to its respective set point.
 - Low Temp:** The LED will light when the zone temperature is below its respective set point. It is normal for all zones to indicate "Low Temp" as the system heats from a cold start-up.
- ⑥ **Temperature Display:** Displays Service Clock (See page 7 for function detail), Set or Actual temperatures of heated zones (e.g. Tank, Hose, Gun, Grid) as well as programmed values of other features (e.g. High Limit, Auto Standby Timer, etc.). During operation after initial power on, the actual Tank temperature is displayed as default display.



Temperature and System Controls

- 7 **Zone Temp and Status Display buttons:** Press and hold any zone button, (e.g. Tank, Hose, Gun, Grid) to display the set temperature, then release to see the actual temperature. The selected zone's status (Sensor Fault, Ready, etc.) will also be displayed in the Zone Status area.
 - 8 **Hose/Gun On/Off buttons:** Turns the power ON or OFF to each hose/gun group individually. The indicator light illuminates accordingly.
 - 9 **Front Panel Lock:** Used to secure the front panel. To enhance the systems tamper resistance, a key lock option is available.
 - 10 **Auto Standby Timer*:**
 - ▶ To change, place Set/Run switch in set position. Push the Auto Standby button and use the "+" and "-" arrows to adjust from 0 to 5 hours. Return the Set/Run to run position.
 - 11 **Power OFF Timer:**
 - ▶ To change, place Set/Run switch in set position. Push the Power Off button and use the "+" and "-" arrows to adjust from 0 to 5 hours. Return the Set/Run to run position.
- Manual Standby*:** If activated, LED will light and all temperatures will lower to set % value.
- ▶ To change % of standby, place Set/Run switch in set position. Push the Temperature Set Back Control button and use the "+" and "-" arrows to adjust from 20% to 70%. Return the Set/Run switch to run position. The programmed % applies to both Auto and Manual Standby.
- 12 **Pump Ready Delay Timer*:** If additional melted adhesive is needed, this feature adds up to 60 minutes of time before allowing the pump motor to work.
 - ▶ To change, place Set/Run switch in set position. Push the Pump Ready delay button and use the "+" and "-" arrows to adjust from 0 to 60 minutes. Return the Set/Run switch to run position.
- 13 **Pump Ready:** The pump motor will not operate until the actual tank temperature is within 25°F (14°C) of set temperature.
- 14 **Pump ON/OFF Switch:** The pump will only operate when: this switch is ON, the "READY" LED is lit (see #14 above), and a trigger input is provided.
- 15 **Set/Run switch*:** Should be in Run Mode during normal operation. Place in Set Mode to change set temperatures of any zone, (e.g. Tank, Hose, Gun, Grid) or values of other features (e.g. High Limit, Auto Standby Timer, etc.). Return switch to Run Mode when finished with adjustment(s).

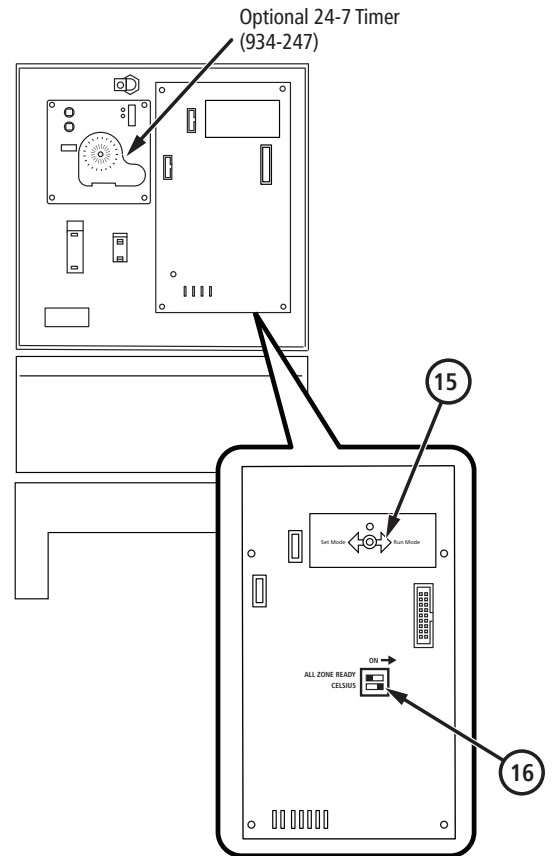

- 16 **All Zone Ready:** To restrict operation of the pump until all active zones, (e.g., Tank, Hose and Gun) have reached their respective Ready Temp, set the All Zone Ready dip switch to ON.
 - °F vs °C: Dip switch used to change from °F or °C (default is Fahrenheit) For Celsius set the switch to ON.

*System will return to normal operation if no adjustments are made for 15 seconds. Set Mode LED on front panel will flash, indicating switch is still in Set Mode position.

Tank Zone Sensor Fault (Open Loop)

This fault is a safety feature that is provided with all ETL approved ProFlex systems; it occurs when the tank zone has been attempting to heat, but the temperature has not increased for ten (10) minutes. If this fault occurs, the Zone Status LED will show a Tank Sensor Fault with a non-zero temperature reading, and the tank zone will no longer heat until the following procedure is executed.

Address the Issue

1. Ensure that the tank RTD is properly installed in the heater plate (Caution: Tank, Pump, RTD, and Heater Plate may be Hot! Use proper PPE).
2. Power Off the system, disconnect from main power, and check the Tank Fuses and Transformer Fuses. Replace if necessary.

Clear the Open Loop Fault

1. Turn the Power OFF.
2. Press and Hold the High Limit Button and turn the Power ON.
3. When the High Limit Temperature is displayed on the Temperature Display, turn the Power OFF and then back ON. The Open Loop Fault is cleared.

How to Read Revised Service Clock Display Hours are posted at initial power on.

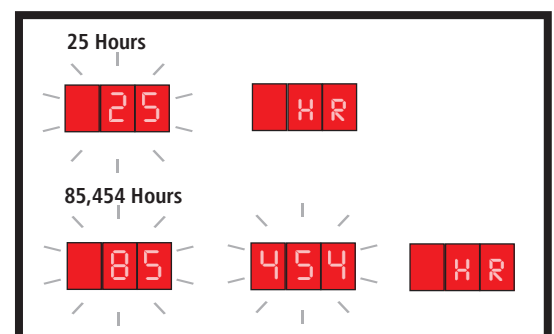

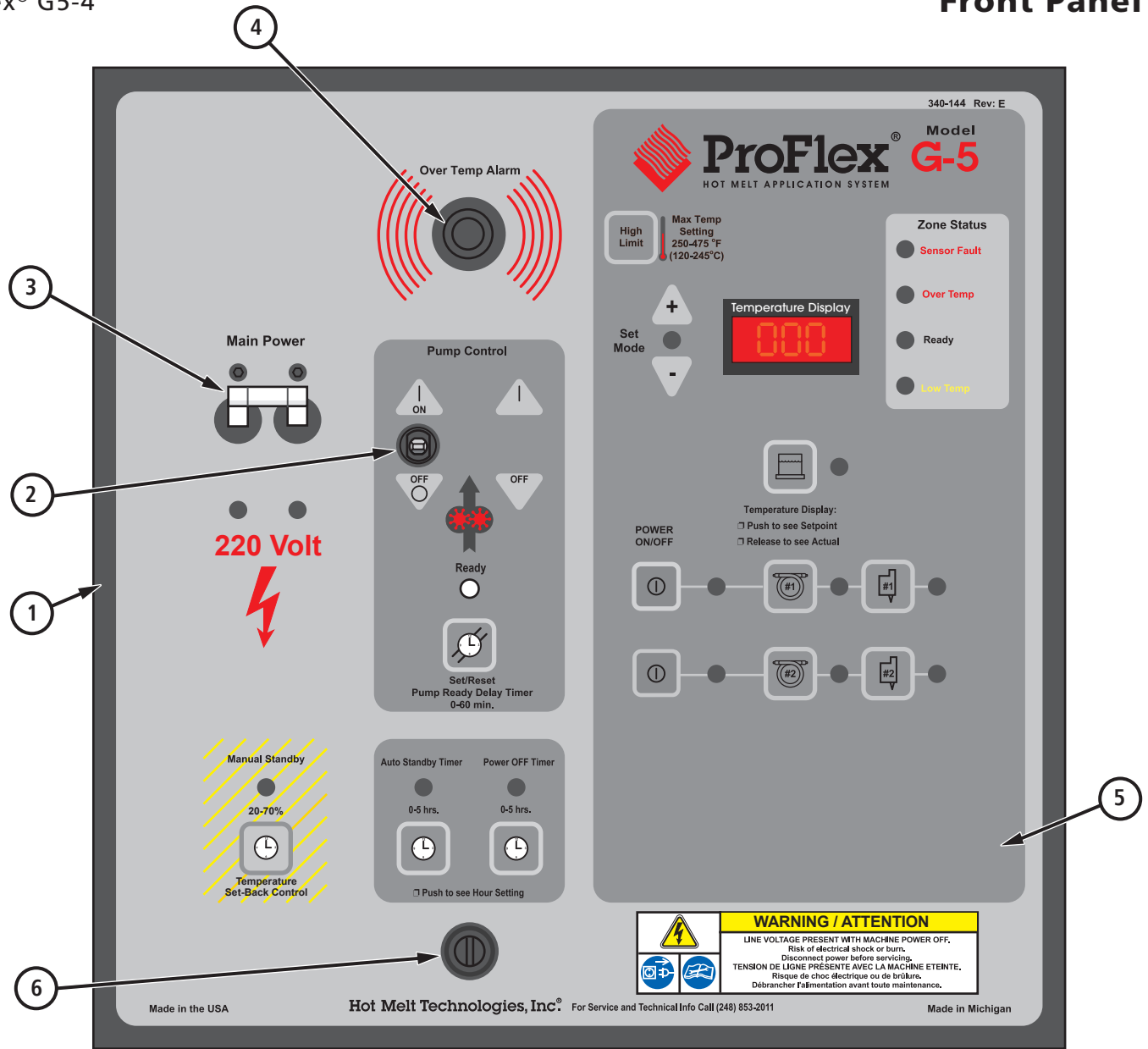

BILL OF MATERIALS

ITEM	DESCRIPTION	PART NO	QTY
1	Control Box Assembly	934-561	1
2	Pump Switch, 10 A	211-010	1
3	Main Power Switch, 40 A, 220 VAC	211-017	1
4	Over Temp Alarm	243-006	1
5	Decal	340-144	1
6a	Front Panel Latch, Non-Locking	340-030	1
6b	Front Panel Latch, Locking (Optional)	340-032	1



Fuse & Relay Chart

ProFlex® G5-4

Single Motor

TANK HEATER FUSE			
ITEM	DESCRIPTION	REPLACE WITH	PART NO
F1/F2	2400 W	20 A, 600 VAC (KLKR)	214-320
	3000 W	20 A, 600 VAC (KLKR)	214-320
	4800 W	30 A, 600 VAC (KLKR)	214-330
	6000 W	35 A, 600 VAC (KLKR)	214-335

TEMP CONTROL BOARD			
ITEM	DESCRIPTION	REPLACE WITH	PART NO
F3/F3B	Hose up to 12'	5 A, 125 VAC (GMA)	214-105
	Hose 12'-20'	8 A, 125 VAC (GMA)	214-108
	Hose 12'-24'	10 A, 125 VAC (GMA)	214-110
F4/F4B	Handgun	2 A, 125 VAC (GMA)	214-102
	Automatic Valve	-	Call TSS
F5/F5B	Hose up to 12'	5 A, 125 VAC (GMA)	214-105
	Hose 12'-20'	8 A, 125 VAC (GMA)	214-108
	Hose 20'-24'	10 A, 125 VAC (GMA)	214-110
F6/F6B	Handgun	2 A, 125 VAC (GMA)	214-102
	Automatic Valve	-	Call TSS
F7/F8	DC Power Supply	2 A, 250 VAC (GMD)	214-503

MOTOR CONTROL BOARD			
ITEM	DESCRIPTION	REPLACE WITH	PART NO
F1/F2	Transformer Primary	1 A, 125 VAC (GMA)	214-101
F4	Transformer Secondary	1 A, 125 VAC (GMA)	214-101
F5/F7	A/C Motor	5 A, 125 VAC (GMA)	214-105
	D/C Motor	8 A, 125 VAC (GMA)	214-108
F6/F8	Accessory Output	2 A, 125 VAC (GMA)	214-102

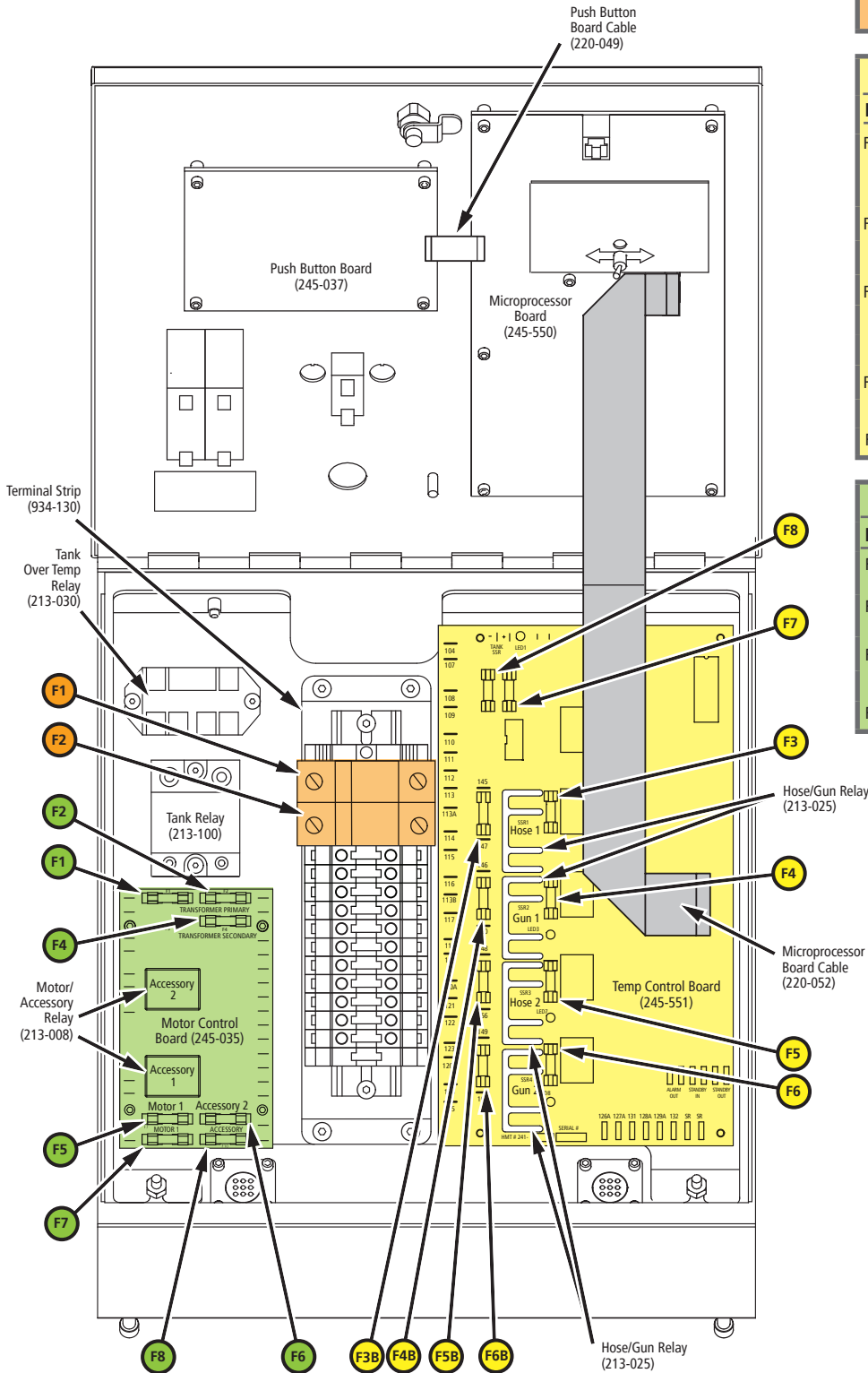

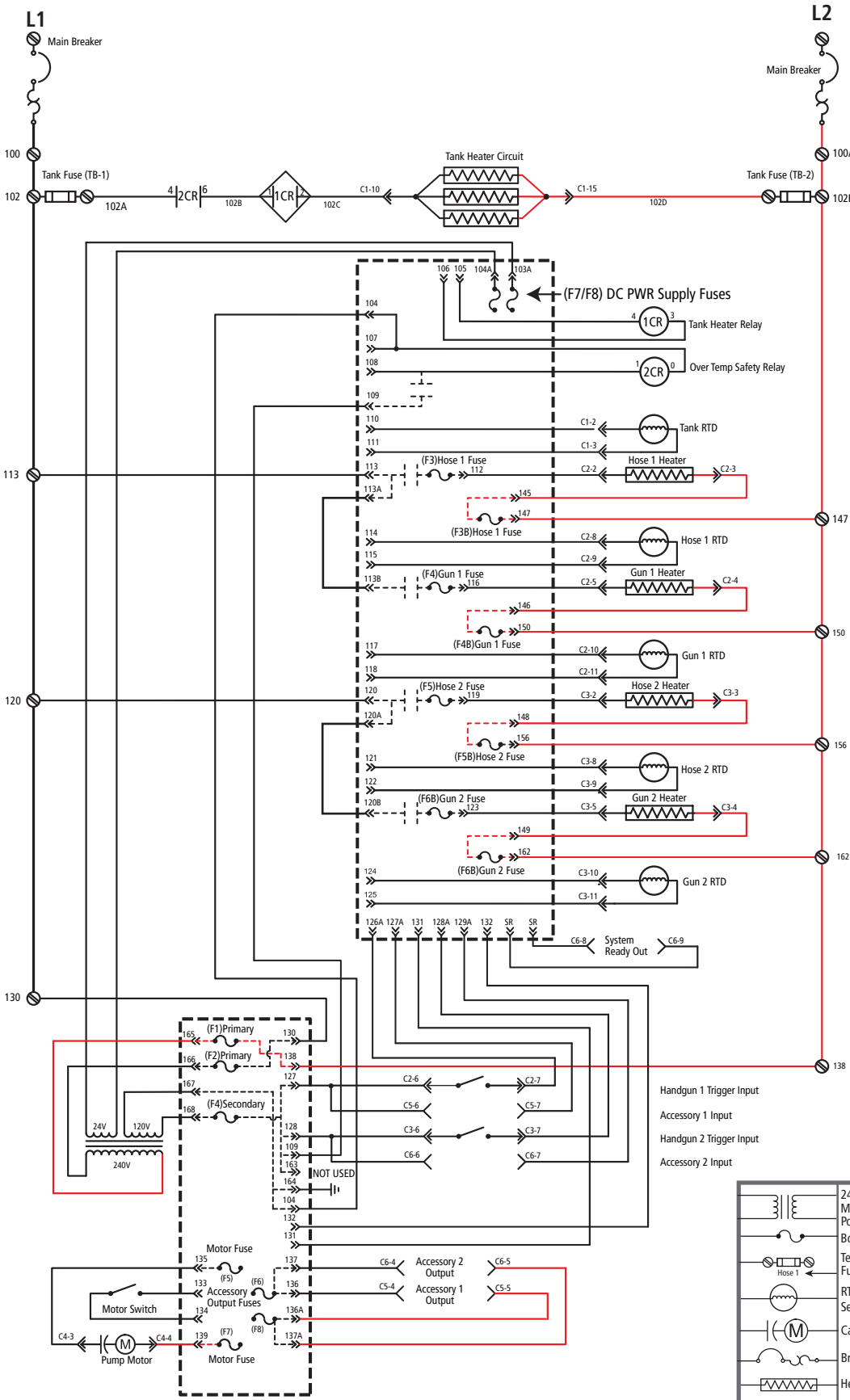

POWER CONNECTION

220 VAC, Single Phase

L1 ← 220V → L2 G

CONNECTOR IDENTIFICATION

C1	Tank
C2	Hose 1
C3	Hose 2
C4	Motor 1
C5	Accessory 1
C6	Accessory 2

SYMBOL LEGEND

	24V Transformer		Relay Number
	Motherboard Power Supply		Relay (Coil)
	Board Mounted Fuse		Wire Location
	Terminal Block Fuse Description		Relay (Contacts)
	RTD Temperature Sensor		AMP Connector & Pin Number
	Capacitor and Motor		AMP Quick Disconnect
	Breaker Switch		Stakon Connector
	Heater		Wire Termination
			Amber Light



Ground Fault Equipment Protection (GFEP)

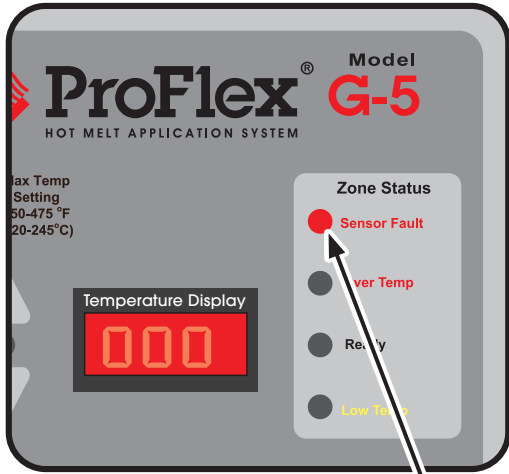

Sensor Fault Indicator

This adhesive dispensing system is equipped with a Ground Fault Equipment Protector (GFEP) on the the hose zones and is designed to protect against an unintended ground fault.

If a ground fault is detected in a hose zone,

- ▶ The GFEP will remove power from the faulted zone.
- ▶ The Sensor Fault Indicator LED on the front panel will turn on.
- ▶ The GFEP Indicator LED for the faulted zone will turn on.
- ▶ The GFEP will remain faulted until the source of the fault is removed AND the Main Power is cycled.

If a ground fault is detected during operation, contact HMT Technical Service & Support for assistance.

Ground Fault Equipment Protector (GFEP)

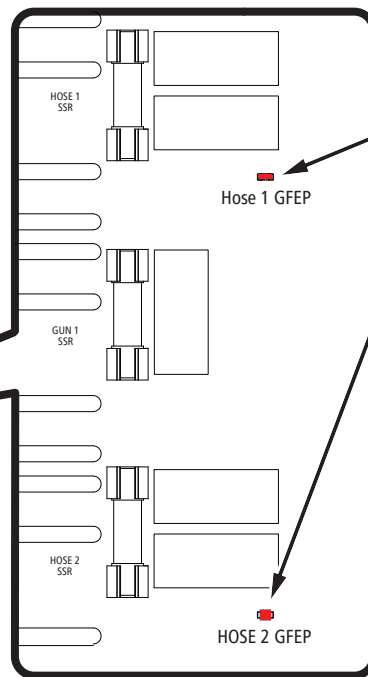
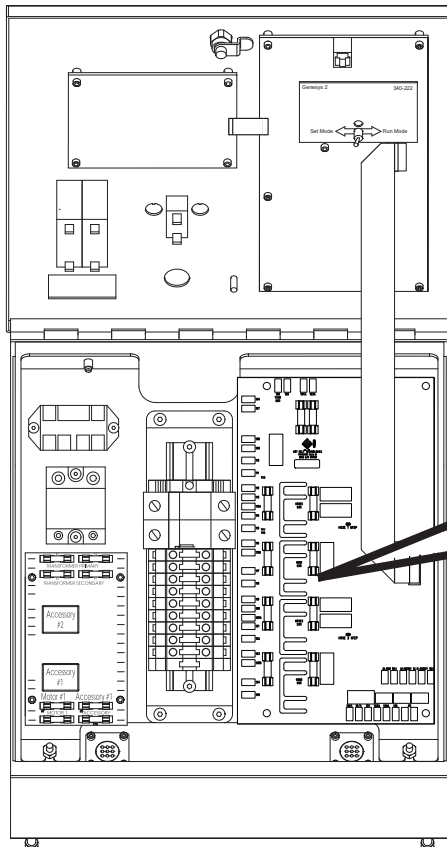

GFEP Indicator LEDs

- ON - GFEP Fault Detected
Hose Zone is Inactive
- OFF - No GFEP Fault Detected
Hose Zone is Active



Warranty Information

This Warranty extends to the original purchaser only and commences on the date of the original purchase.

Any part of the Hot Melt Technologies (HMT®) adhesive supply unit (ASU) manufactured by HMT® and found in the reasonable judgement of HMT to be defective in material and workmanship, will be repaired or replaced by HMT without charge for parts or labor.

This Warranty is limited to:

- a) One (1) year from initial use,
- b) Eighteen (18) months from date of purchase, or
- c) Two thousand (2,000) hours of use, whichever comes first.

The ASU including any defective part must be returned to HMT within the warranty period. All transportation expenses to HMT for warranty work and the expense of returning it to the owner will be paid for by the owner. HMT's responsibility in respect to claims is limited to (at its option) making the required repairs, adjustment, or replacements. No claim of breach of warranty shall be cause for cancellation of the contract of sale of any HMT ASU.

This warranty does not cover any ASU that has been subject to misuse, abuse, negligence, or accident, or which has been operated in any way contrary to the operating instructions. Warranty does not apply to any damage to the ASU that is the result of improper maintenance or installation.

This warranty does not cover any ASU that has been altered or modified by the customer. In addition, the warranty does not extend to repairs made necessary by normal wear or by the use of hot melt materials in the ASU which in the reasonable opinion of HMT are either incompatible with the ASU or adversely affect its operation, performance, or durability. This warranty does not extend to any accessory attachments to the ASU that are warranted separately for different periods of time. Other components supplied by HMT as part of a system will carry the warranty of the original manufacturer.

This warranty does not extend to an ASU damaged during shipment. Risk of loss or damage to the ASU shall pass to the buyer.

HMT reserves the right to change or improve the design of any ASU, or part of an ASU, without assuming any obligation to modify any ASU previously manufactured.

HMT assumes no responsibility for incidental, consequential or other damages including but not limited to: expense for hot melts, delivery or return freight expenses, mechanics travel time, telephone or telegraph charges, rental of a like product during the time warranty repairs are being performed, travel, loss or damage to personal property, loss of revenue, loss of use of the ASU, loss of time or inconvenience.