



Hot Melt Adhesive

Typical Physical Properties

- ▶ Typical Application Temperature Range: 275°F – 350°F
- ▶ Viscosity: 750 – 1150 cps @ 325°F
- ▶ Softening Point: Approx. 160°F
- ▶ Color: Off-White to Yellow

General Uses and Product Characteristics

HMT-6402 is a versatile, general purpose fugitive adhesive used for a variety of applications. Sprayable.

Storage and Handling Suggestions

Store in cool, dry place in the original shipping container only. Keep container closed and tightly sealed when not in use to avoid contamination.

Clean-up and Safety Information

For purging, use HMT's 1200-HMP purge compound. To minimize the risk of burns, we recommend the use of eye protection and protective clothing when working near the hot melt applicator.

Packaging Information

Package changes can occur without notice.

6402

Chemistry

Synthetic Resin

Form

Pillows

Shelf Life

One year from the date of shipment.

Meets composition requirements of Indirect Food Additives Regulation 21CFR175.105 "Adhesives."

Standard Disclaimer

The data presented is based on tests standard to the adhesive industry. Because we have no control over the application process or the substrates used by the customer, HMT can not certify the performance of the assembly the adhesive is used on. HMT will assume no responsibility for results obtained or for incidental or consequential damages arising from the use of this adhesive.

Approx. Pallet Dimensions: L=48", W=40", H=51"
 Full Pallet Weight: 1200 lb Net (40 boxes)
 Rows per Full Pallet: 4
 Weight per Row: 300 lb Net (10 boxes)

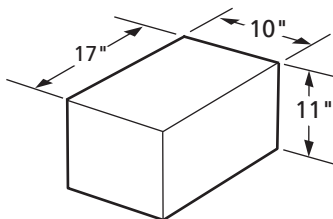

Container Type: Box
 Container Dimensions: L=17", W=10", H=11"
 Container Weight: 30 lb Net

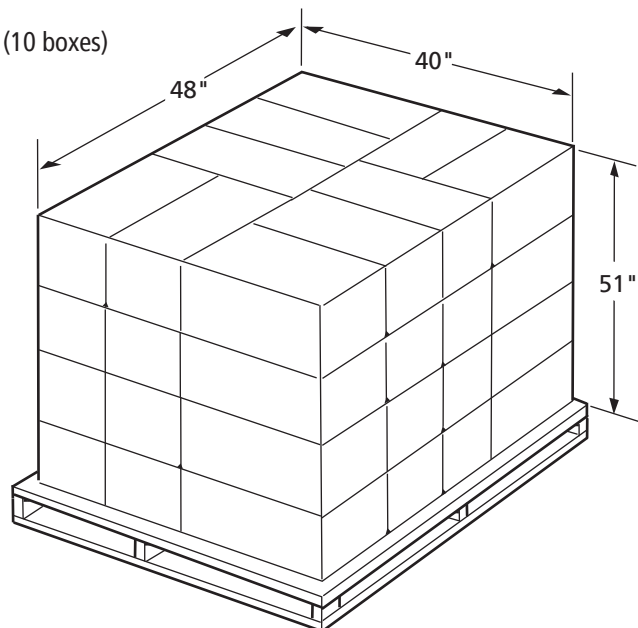

Hot Melt Technologies, Inc.
 No One Puts It Together Like HMT[®]

1723 W Hamlin Road, Rochester Hills, MI 48309 (248) 853-2011 www.hotmelt-tech.com

11/01/2024